

Data Sheet

Customer:

Product: Thick Film Array Chip Resistor - CN Series

Size: 0201x2(Flat) / 0201x4(Flat) / 0402x4 / 0603x4 /
0402x4(Concave) / 0603x4(Concave)

Issued Date: 15-Jun-22

Edition: REV.B8



VIKING TECH CORPORATION
光頡科技股份有限公司
No.70 Guangfu N. Rd., Hukou
Township, Hsinchu County 303,
Taiwan

TEL:886-3-5972931
FAX:886-3-5972935•886-3-5973494
E-mail:sales@viking.com.tw

VIKING TECH CORPORATION KAOHSIUNG BRANCH
光頡科技股份有限公司高雄分公司
No.248-3, Sin-Sheng Rd., Cian-Jhen Dist., Kaohsiung,
806, Taiwan

TEL:886-7-8217999
FAX:886-7-8228229
E-mail:sales@viking.com.tw

VIKING ELECTRONICS (WUXI) CO., LTD.
光頡電子(無錫)有限公司
No.22 Xixia Road, Machinery & Industry Park,
National Hi-Tech Industrial Development Zone
of Wuxi, Wuxi, Jiangsu Province, China
Zip Code:214028
TEL:86-510-85203339
FAX:86-510-85203667•86-510-85203977
E-mail:china@viking.com.tw

Produced by (QC)	Checked (QC)	Approved by (QC)	Prepared by (Sales)	Accepted by (Customer)
15-Jun-22	15-Jun-22	15-Jun-22		
Alice Hsiao	Susan Huang	Susan Huang		

Thick Film Array Chip Resistor

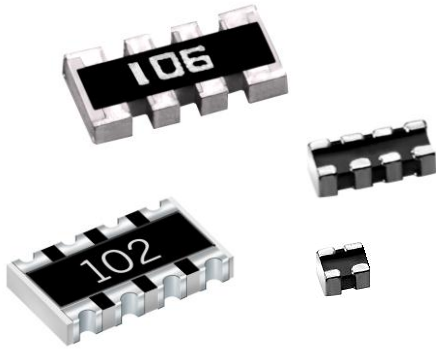

Scope

– This specification applies to all sizes of rectangular-type fixed chip resistors with Ruthenium-base as material.

Features

- Small size and light weight
- Reduction of assembly costs and matching with placement machines
- Reliability, high quality
- Suitable for IR reflow soldering and wave soldering

Construction

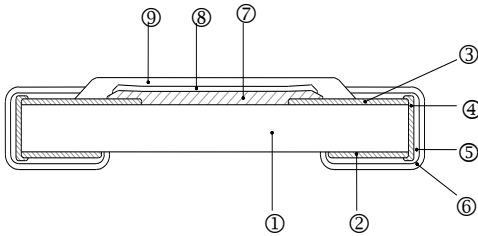

Applications

- Entertainment
- Computer & Related Products
- Communication Equipment
- Power Equipment
- Measuring Instrument

① Alumina Substrate	④ Edge Electrode	⑦ Resistor Layer
② Bottom Electrode	⑤ Barrier Layer	⑧ Primary Overcoat
③ Top Electrode	⑥ External Electrode	⑨ Secondary Overcoat

Dimensions

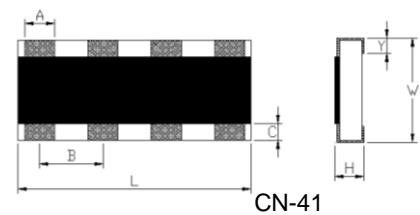
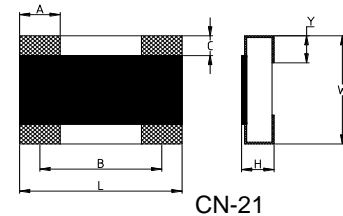
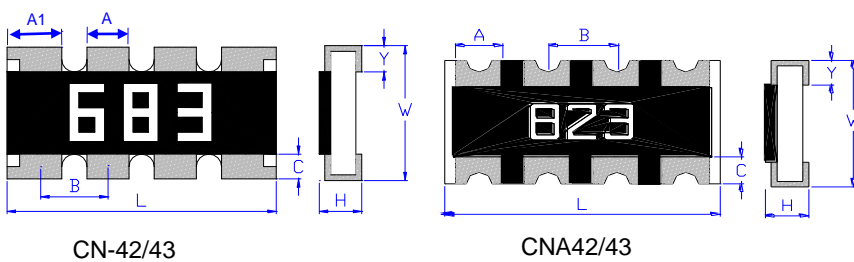

Type	Number of Resistors	L (mm)	W (mm)	H (mm)	A (mm)	A1 (mm)	B (mm)	C (mm)	Y (mm)	Weight (g) (1000pcs)
CN-21	2	0.80±0.10	0.60±0.10	0.35±0.10	0.30±0.10	-	0.50±0.10	0.15±0.10	0.15±0.10	0.500
CN-41	4	1.40±0.10	0.60±0.10	0.35±0.10	0.20±0.10	-	0.40±0.10	0.10±0.07	0.15±0.05	0.833
CN-42	4	2.00±0.10	1.00±0.10	0.45±0.10	0.30±0.10	0.40±0.10	0.50±0.05	0.22±0.15	0.22±0.15	2.817
CN-43	4	3.20±0.15	1.60±0.15	0.55±0.10	0.50±0.15	0.65±0.10	0.80±0.05	0.30±0.15	0.30±0.15	8.288
CNA42	4	2.00±0.10	1.00±0.10	0.40±0.10	0.30±0.10	-	0.50±0.05	0.20±0.10	0.25±0.10	3.003
CNA43	4	3.20±0.15	1.60±0.15	0.60±0.10	0.60±0.15	-	0.80±0.05	0.30±0.15	0.30±0.15	10.115

Part Numbering

CN-	43	J	L	7	- - - 1 0 R
Product Type	Dimensions	Resistance Tolerance	Function Code	Packaging Code	Resistance
CN- (Flat/Convex) CNA (Concave)	21: 0201x2 41: 0201x4 42: 0402x4 43: 0603x4	F: ±1% J: ±5%	L: 4P2R/8P4R	6: 7" Reel 10Kpcs 7: 7" Reel 5Kpcs A: 10" Reel 10Kpcs B: 10" Reel 20Kpcs C: 13" Reel 40Kpcs D: 13" Reel 20Kpcs	--- 1R2: 1.2Ω --- 3K3: 3.3KΩ --- 10K: 10KΩ -- 100K: 100KΩ "-" to fill up 6 spaces

Derating Curve

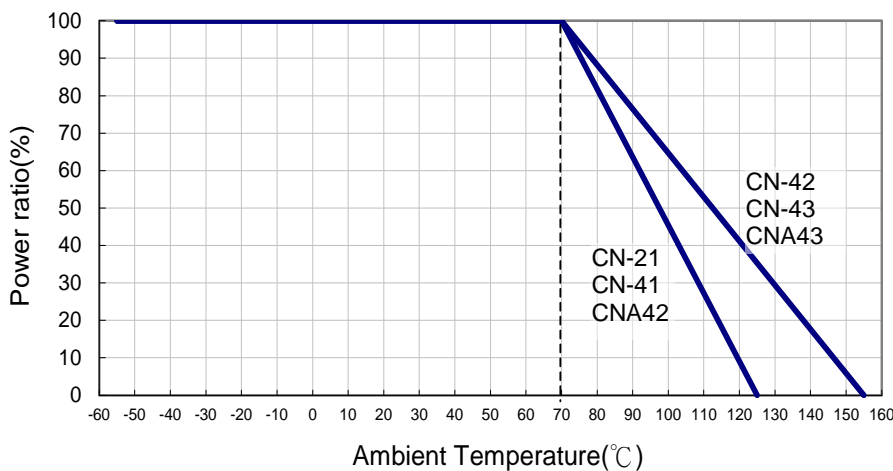

Standard Electrical Specifications

Item Type	Power Rating at 70°C Jumper Rated Current	Operating Temp. Range	Max. Operating Voltage	Max. Overload Voltage	Number of Resistors	Resistance Range		TCR (PPM/°C)
						±1% (E24,E96)	±5% (E24)	
CN-21	1/32W Jumper: 0.5A	-55 ~ +125°C	12.5V	25V	2	-	3Ω - 9.1Ω	±300
						10Ω - 1MΩ		±200
	-					0Ω (<50mΩ)	-	
CN-41	1/32W Jumper: 0.5A	-55 ~ +125°C	12.5V	25V	4	10Ω - 1MΩ		±200
						-	0Ω (<50mΩ)	-
	10Ω - 1MΩ					±200		
CN-42	1/16W Jumper: 1A	-55 ~ +155°C	25V	50V	4	10Ω - 1MΩ	1Ω - 1MΩ	±200
						-	0Ω (<50mΩ)	-
	10Ω - 1MΩ					±200		
CN-43	1/10W Jumper: 1A	-55 ~ +155°C	50V	100V	4	10Ω - 1MΩ	1Ω - 1MΩ	±200
						-	0Ω (<50mΩ)	-
	10Ω - 1MΩ					±200		
CNA42	1/16W Jumper: 1A	-55 ~ +125°C	50V	100V	4	10Ω - 1MΩ		±200
						-	0Ω (<50mΩ)	-
	10Ω - 1MΩ					±200		
CNA43	1/16W Jumper: 1A	-55 ~ +155°C	50V	100V	4	10Ω - 1MΩ		±200
						-	0Ω (<50mΩ)	-
	10Ω - 1MΩ					±200		

Operating Voltage= $\sqrt{P \cdot R}$ or Max. Operating Voltage listed above, whichever is lower.

Overload Voltage= $2.5 \cdot \sqrt{P \cdot R}$ or Max. Overload Voltage listed above, whichever is lower.

■ Viking is capable of manufacturing the optional spec based on customer's requirement.

■ Equivalent Circuit Diagram

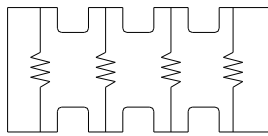

CN-42/43

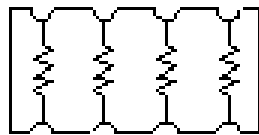

CNA42/43

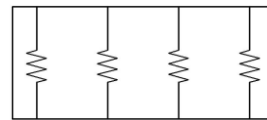

CN-41

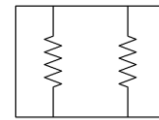

CN-21

■ Soldering Condition (Ref. IPC/JEDEC J-STD-020 & J-STD-002)

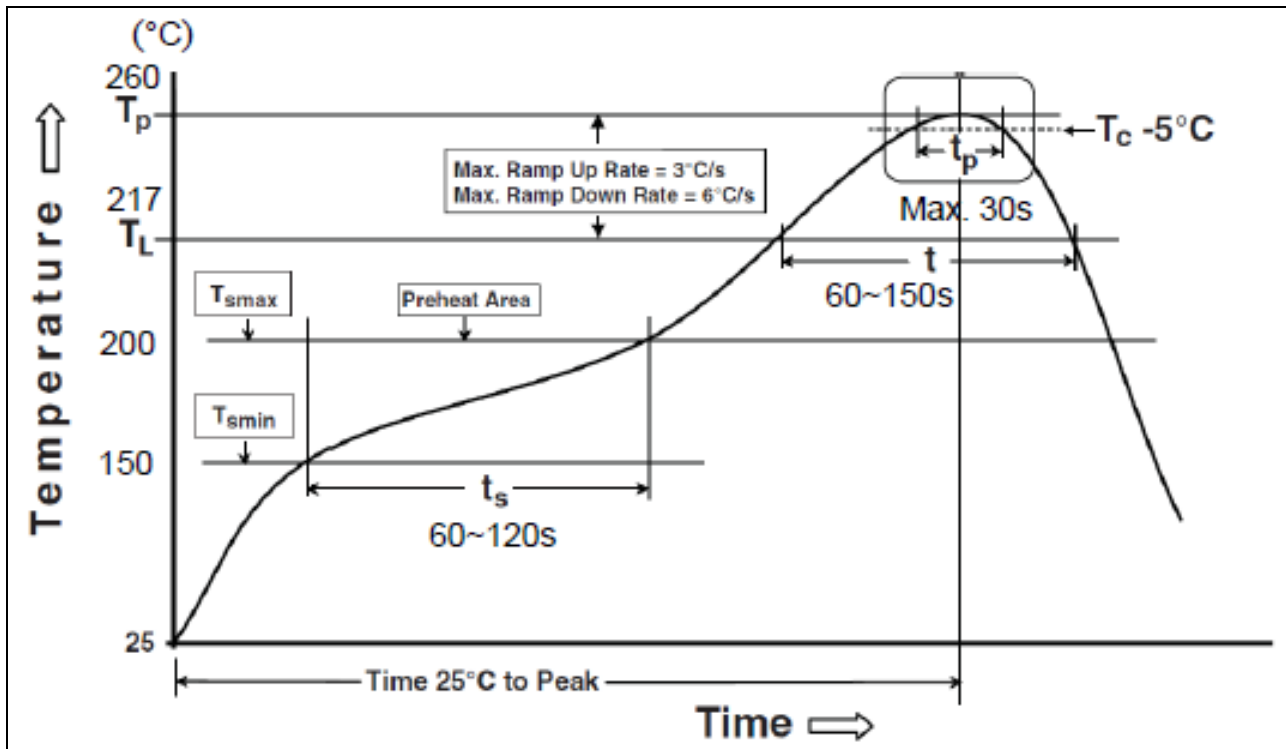

Reflow Profiles	
Profile Feature	Pb-Free Assembly
Preheat Min. Temperature (T_{smin}) Max Temperature (T_{smax}) Preheating time (t_s) from (T_{smin} to T_{smax})	150 °C 200 °C 60-120 seconds
Ramp-up rate (T_L to T_p)	3 °C/second max.
Liquidous temperature (T_L) Time (t_L) maintained above T_L	217 °C 60-150 seconds
Min. Peak temperature (T_p min)	235°C
Max. Peak temperature (T_p max)	260°C
Time (t_p) within 5 °C of the specified classification temperature (T_c)	30 seconds max.
Ramp-down rate (T_p to T_L)	6 °C/second max.
Time 25 °C to peak temperature	8 minutes max.

Environmental Characteristics

Item	Requirement			Test Method
	±1%	±5%	Jumper	
Temperature Coefficient of Resistance (T.C.R.)	As Spec.			JIS-C-5201-1 4.8 IEC-60115-1 4.8 At 25°C/-55°C and 25°C/+125°C, 25°C is the reference temperature
Short Time Overload	±(1.0%+0.05Ω) CNA42/43: ±(2.0%+0.05Ω)	±(2.0%+0.05Ω)	<50mΩ	JIS-C-5201-1 4.13 IEC-60115-1 4.13 RCWV*2.5 or Max. Overload Voltage whichever is lower for 5 seconds
Insulation Resistance	≥10G			JIS-C-5201-1 4.6 IEC-60115-1 4.6 Max. Overload Voltage for 1 minute
Endurance	±(2.0%+0.10Ω)	±(3.0%+0.10Ω)	<50mΩ CN-21/41 & CNA42/43: <100mΩ	JIS-C-5201-1 4.25 IEC-60115-1 4.25.1 70±2°C, RCWV for 1000 hrs with 1.5 hrs "ON" and 0.5 hr "OFF"
Damp Heat with Load	±(2.0%+0.10Ω)	±(3.0%+0.10Ω)	<50mΩ CNA42/43: <100mΩ	JIS-C-5201-1 4.24 IEC-60115-1 4.24 40±2°C, 90~95% R.H., RCWV for 1000 hrs with 1.5 hrs "ON" and 0.5 hr "OFF"
Dry Heat	±(1.0%+0.05Ω)	±(1.5%+0.10Ω) CN-21/41: ±(3.0%+0.10Ω)	<50mΩ CN-21/41: <100mΩ	JIS-C-5201-1 4.23 IEC-60115-1 4.23.2 at +125/+155°C for 1000 hrs
Bending Strength	±(1.0%+0.05Ω)	±(1.0%+0.05Ω)	<50mΩ	JIS-C-5201-1 4.33 IEC-60115-1 4.33 Bending once for 60 seconds with 3mm
Solderability	95% min. coverage			JIS-C-5201-1 4.17 IEC-60115-1 4.17 245±5°C for 3 seconds
Resistance to Soldering Heat	±(0.5%+0.05Ω) CNA42/43: ±(1%+0.05Ω)	±(1.0%+0.05Ω)	<50mΩ	JIS-C-5201-1 4.18 IEC-60115-1 4.18 260±5°C for 10 seconds
Voltage Proof	No breakdown or flashover			JIS-C-5201-1 4.7 IEC-60115-1 4.7 1.42 times Max. Operating Voltage for 1 minute
Leaching	Individual leaching area ≤5% Total leaching area ≤ 10%			JIS-C-5201-1 4.18 IEC-60068-2-58 8.2.1 260±5°C for 30 seconds
Rapid Change of Temperature	±(0.5%+0.05Ω)	±(1.0%+0.05Ω)	<50mΩ	JIS-C-5201-1 4.19 IEC-60115-1 4.19 -55°C to +125/+155°C, 5 cycles

RCWV(Rated Continuous Working Voltage)=√(P*R) or Max. Operating Voltage whichever is lower.

Storage Temperature: 15~28°C; Humidity < 80%RH

Shelf Life: 2 years from production date.

Thick Film Array Chip Resistor

Recommend Land Pattern

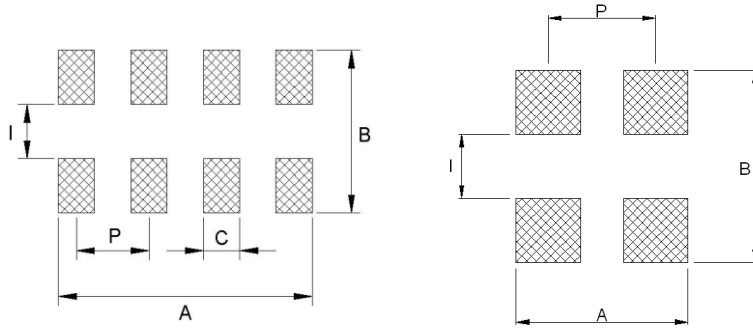

Type	A (mm)	B (mm)	C (mm)	I (mm)	P (mm)
CN-21	0.80	0.90	--	0.30	0.50
CN-41	1.40	0.90	0.20	0.30	0.40
CN-42	2.10	1.80	0.30	0.50	0.50
CN-43	3.10	2.85	0.45	0.80	0.80
CNA42	2.10	1.80	0.30	0.50	0.50
CNA43	3.10	2.85	0.45	0.80	0.80

Packaging

Reel Specifications & Packaging Quantity

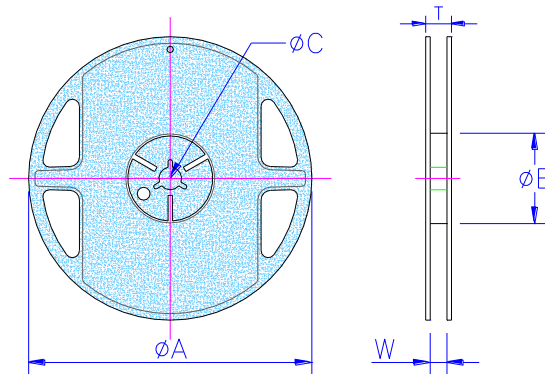

Type	Packaging Quantity	Tape Width	Reel Diameter	ΦA (mm)	ΦB (mm)	ΦC (mm)	W (mm)	T (mm)
CN-21 CN-41	Paper 10K	8mm	7 inch	178.5±1.5	60 ^{+1/-0}	13.0±0.2	9.0±0.5	12.5±0.5
CN-42 CNA42	Paper	10K	7 inch	178.5±1.5	60 ^{+1/-0}	13.0±0.2	9.0±0.5	12.5±0.5
		20K	10 inch	254±1.0	100±0.5	13.0±0.2	9.5±0.5	13.5±0.5
		40K	13 inch	330±1.0	100±0.5	13.0±0.2	9.5±0.5	13.5±0.5
CN-43 CNA43	Paper	5K	7 inch	178.5±1.5	60 ^{+1/-0}	13.0±0.2	9.0±0.5	12.5±0.5
		10K	10 inch	254±1.0	100±0.5	13.0±0.2	9.5±0.5	13.5±0.5
		20K	13 inch	330±1.0	100±0.5	13.0±0.2	9.5±0.5	13.5±0.5

Thick Film Array Chip Resistor

Paper Tape Specifications

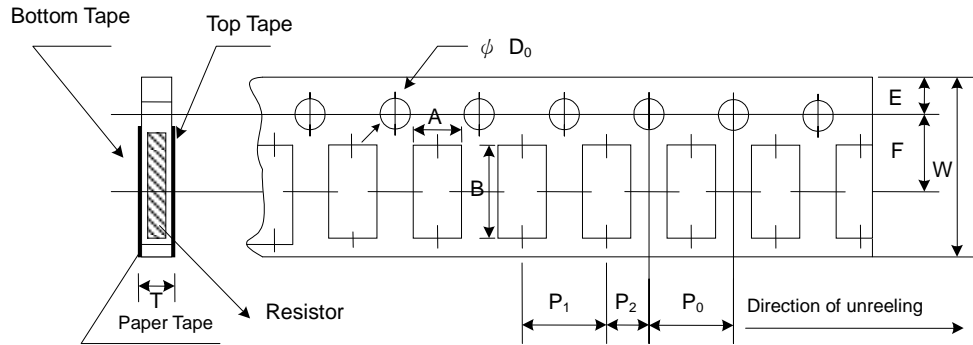

Type	A (mm)	B (mm)	W (mm)	E (mm)	F (mm)	P ₀ (mm)	P ₁ (mm)	P ₂ (mm)	ΦD ₀ (mm)	T (mm)
CN-21	0.77±0.05	0.97±0.05	8.0±0.2	1.75±0.1	3.5±0.05	4.0±0.1	2.0±0.05	2.0±0.05	1.50+0.1,-0	0.50±0.1
CN-41	0.77±0.05	1.57±0.05	8.0±0.2	1.75±0.1	3.5±0.05	4.0±0.1	2.0±0.05	2.0±0.05	1.50+0.1,-0	0.50±0.1
CN-42	1.20±0.1	2.20±0.1	8.0±0.2	1.75±0.1	3.5±0.05	4.0±0.1	2.0±0.05	2.0±0.05	1.50+0.1,-0	0.70±0.1
CN-43	1.95±0.1	3.50±0.1	8.0±0.2	1.75±0.1	3.5±0.05	4.0±0.1	4.0±0.05	2.0±0.05	1.50+0.1,-0	0.85±0.1
CNA42	1.20±0.1	2.20±0.1	8.0±0.2	1.75±0.1	3.5±0.05	4.0±0.1	2.0±0.05	2.0±0.05	1.50+0.1,-0	0.70±0.1
CNA43	1.95±0.1	3.50±0.1	8.0±0.2	1.75±0.1	3.5±0.05	4.0±0.1	4.0±0.05	2.0±0.05	1.50+0.1,-0	0.85±0.1

■ Marking

No Marking for CN-21/CN-41/CNA42

Jumper for all: Letter "0"

1% for CN-42/CN-43/CNA43: 4 digits marking (non-including E24 series)

Example:

Resistance	102Ω	2.49KΩ	30K1Ω	49.9KΩ	121KΩ
marking	1020	2491	3012	4992	1213

1% & 5% for CN-42/CN-43/CNA43: 3 digits marking in E24

Example: 101=100Ω 102=1KΩ (1st and 2nd are E24 code and 3rd code is multiplier)

E24 code	10	11	12	13	15	16	18	20	22	24	27	30	33	36	39	43	47	51	56	62	68	75	82	91
----------	----	----	----	----	----	----	----	----	----	----	----	----	----	----	----	----	----	----	----	----	----	----	----	----

REVISION HISTORY

REVISION	DATE	CHANGE NOTIFICATION	DESCRIPTION
Version A9	Jun 03, 2014	-	- Recommend Land Pattern updated - Environmental Characteristics updated
Version B	May 05, 2015	-	- CNA43 Dimensions updated - Derating Curve updated - CNA42 Electrical Specifications updated - Environmental Characteristics updated - CNA42 Marking updated
Version B1	Jul 15, 2016	-	- Remove Material Description - Modify Storage Temperature
Version B2	Jan 12, 2018	-	- Modify Electrical Specifications (0R)
Version B3	May 20, 2019	-	- Modify TCR Test description
Version B4	Sep 24, 2020	-	- Add CN-42/CN-43 Dimension A1 - Environmental Characteristics updated
Version B5	Mar 10, 2021	-	- Modify Soldering Condition
Version B6	Nov 15, 2021	-	- Increase the shelf life description
Version B7	Feb 15, 2022	-	- Derating Curve changes the temperature range
Version B8	Jun 15, 2022	-	- Modify Soldering Condition